

MONTAGEANLEITUNG ASSEMBLY INSTRUCTION

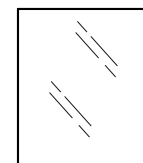

x1

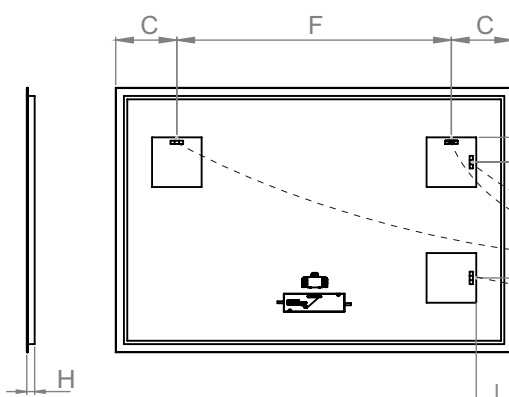
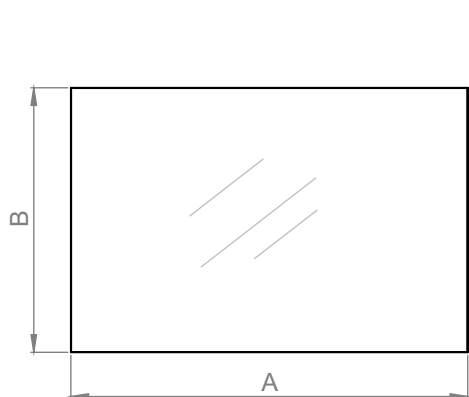

x2



x4

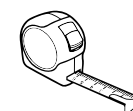
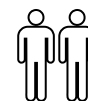

A	B	C	D	E	F	G	H	I
1200	800	185	150	225	830	350	24	110

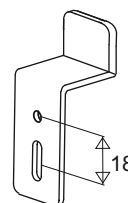

1.



4x Ø8 mm

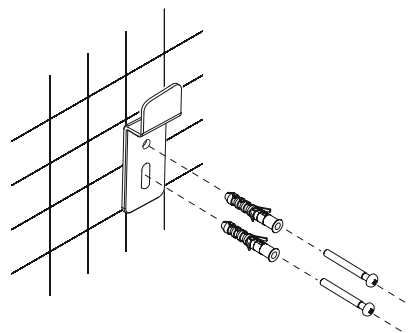

2.

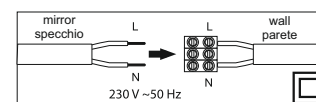
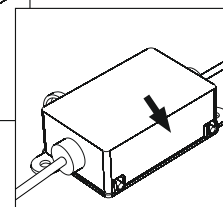
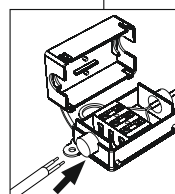
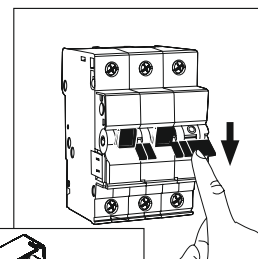

3.

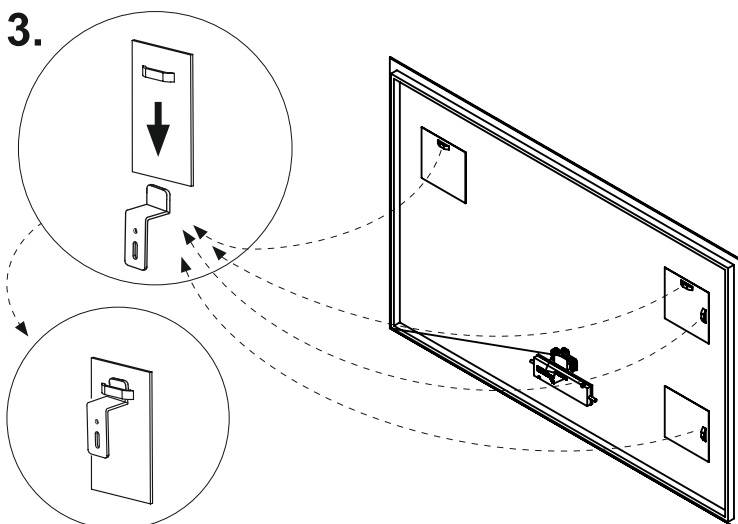

4.

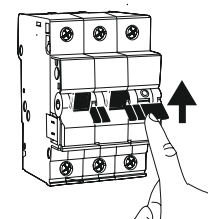



Schalten Sie vor Arbeitsbeginn die Stromversorgung aus!
Die Installation des Produkts sollte von einem zugelassenen Fachmann gemäß den geltenden Installationsvorschriften des jeweiligen Landes nach IEC 364-7-701 und VDE 0100 Teil 701 durchgeführt werden.

Die IP-Schutzart muss beachtet werden.
Die IP-Schutzart muss für den Installationsort geeignet sein.
Der elektrische Anschluss an den Spiegel muss mit einem geeigneten IP54-Stecker erfolgen, um die Schutzklasse aufrechtzuerhalten.

Switch off the power before starting work!
The installation of the product should be carried out by a licensed professional in accordance with the applicable installation regulations of the respective country, following IEC 364-7-701 and VDE 0100 Part 701.

The IP rating must be observed.
The IP rating must be appropriate for the installation location.
The electrical connection to the mirror must be connected using an appropriate IP54 connector to maintain the protection class.

